











Please unscrew all hardware from cushion before assembly.
Por favor de destornillar todos los tornillos del cojin antes de assamblar la silla.

B650/651

| (1)x1 | (2)x1 | (3)x1 (L)x1 (R) |
|--|---|---|
|  |  |  |
| Back | Seat | Right & Left Arm |
| (4)x1 | (5)x1 | (6)x1 |
|  |  |  |
| Mechanism | Gas Lift | Five Star Base |
| (A)x2 |  | M6+50 BACK SCREW |
| (B)x5 |  | M6+35 ARM SCREW |
| (C)x4 |  | M8+22 MECHANISM SCREW |
| (D)x7 |  | WOOD CAP |

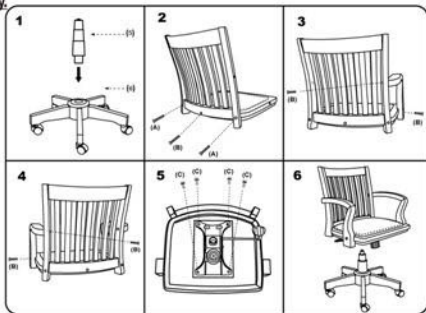

Note: Before inserting the 7(D) wood caps to cover screws holes:

1. **Partially tighten the screws** as indicated on steps 2, 3 & 4.
2. After all 7 screws are in, tighten them and insert all 7(D) wood caps.



Customer Service Hotline: 1-800-593-1888
For further assembly instructions,
please visit our website at www.bosschair.com

Insert and loosely tighten all screws. When assembly is completed, fully tighten all screws before using. This chair is only intended for sitting. Any other use will void the warranty.